

Commercial Pressure Balance Trim S

Finishes : **brushed nickel** Part no. : **04441820**



Description

Features

- Flow: 5.5 GPM (20.6 L/Min)
- Integrated bypass for use with diverter tub spouts
- Temperature and on/off control for 1 outlet

Item details

List Price \$ 261.00

Compliance



Product image



Scale drawing

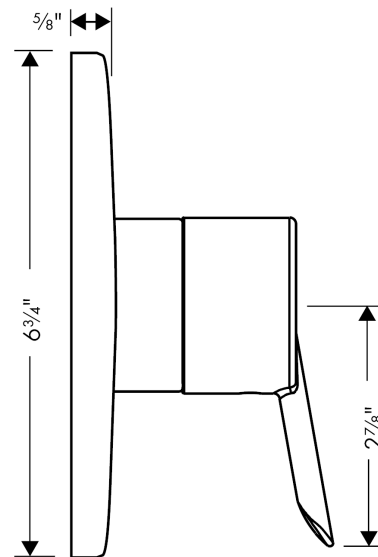

Commercial
Pressure Balance Trim S
 Finishes : **brushed nickel**

Part no. : **04441820**



Exploded drawing

Year of production: >12/11

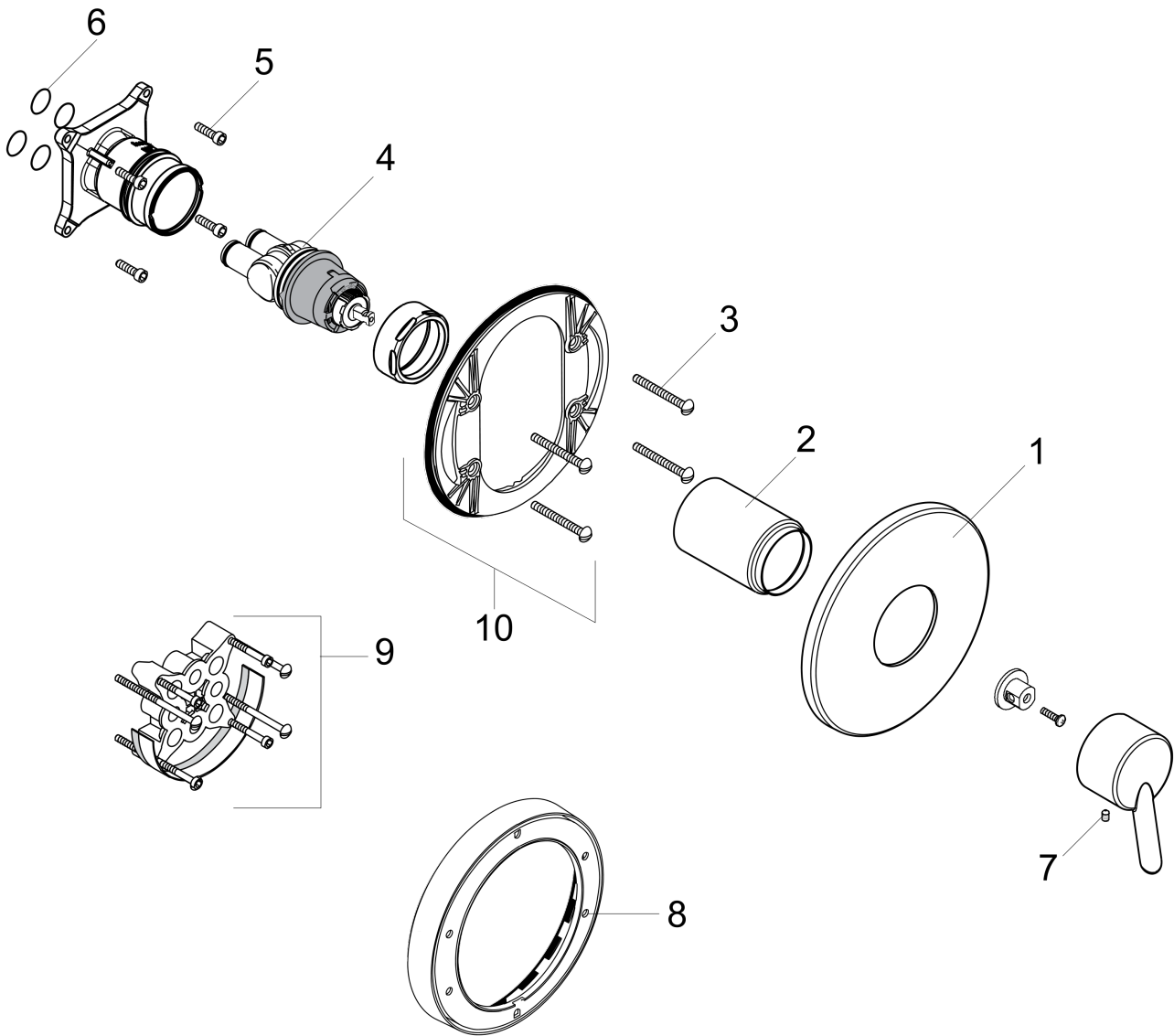

Commercial

Pressure Balance Trim S

Finishes : **brushed nickel**

Part no. : **04441820**



Spare parts list

Year of production: >12/11

Pos.	Description	Part no.	Price	PU
1	escutcheon	88760820	-	1
2	sleeve	88765820	-	1
3	set of fixing screws	96454000	-	1
4	cartridge, assy	88727000	-	1
5	set of screws	96525000	-	1
6	O-ring 16x2	98133000	-	1
7	screw	88654000	-	1
8	extension 22 mm (Ø 170 mm)	13596820	-	1
9	extension 25 mm	13595000	-	1
10	sub plate	96447000	-	1
a	base body	01850181	-	1